



Form 15—Compliance certificate for building design or specification

Version 4 – July 2017

NOTE: This is to be used for the purposes of section 10 of the *Building Act 1975* and/or section 46 of the *Building Regulation 2006*.

RESTRICTION: A building certifier (class B) can only give a compliance certificate about whether building work complies with the BCA or a provision of the Queensland Development Code (QDC). A building certifier (Class B) can not give a certificate regarding QDC boundary clearance and site cover provisions.

1. Property description	Street address (include no., street, suburb/locality and postcode)		
	420 South Pine Road		
	Everton Park	Postcode 4053	
	Lot and plan details (attach list if necessary)		
In which local government area is the land situated?			
Brisbane City Council			
2. Description of component/s certified	Concrete Sleeper Retaining Wall (Steel Posts)		
3. Basis of certification	AS1170.1 – Structural Design Actions (Part 1 : Permanent, imposed and other actions)		
	AS4678 – Earth Retaining Structures		
	AS3600 – Concrete Structures (2009)		
	AS4100 – Steel Structures		
	Prototype testing at the University of Queensland		
4. Reference documentation	Inertia Engineering Design Certificate 9192 & Drawings SK1, SK2, SK3, S4, S5, S6, S7, S8 & S9 Issue C		
5. Building certifier reference number	Building certifier reference number		
6. Competent person details	Name (in full)		
	David Kelly		
	Company name (if applicable)	Contact person	
	Inertia Engineering Pty Ltd	David Kelly	
	Phone no. (business hours)	Mobile no.	Fax no.
	07 3857 7868		07 3262 7359
	Email address		
	Dave.k@inertiaeng.com.au		
	Postal address		
	5B/85 Hudson Road		
Albion	Postcode 4010		
Licence or registration number (if applicable)			
RPEQ 7561			
7. Signature of competent person	Signature	Date	
		24/09/2020	

The *Building Act 1975* is administered by the Department of Housing and Public Works
LOCAL GOVERNMENT USE ONLY

Date received	Reference Number/s
---------------	--------------------

24 September 2020

Ref: 9192 C

Concrib Pty Ltd
601 Boundary Rd
RICHLANDS, QLD 4077

Structural Design Certificate

Concrete Sleeper Retaining Walls (Steel Posts)

420 SOUTH PINE ROAD, EVERTON PARK

We have carried out a structural analysis of the proposed concrete sleeper retaining walls and consider the following design to be structurally adequate as defined by the Building Code of Australia and the principles of structural mechanics.

The design is based upon the assumption that the wall is located in an area not subject to land slip. Investigation of the site for landslip is outside the scope of this certification. Consult a qualified Geotechnical Engineer for analysis in areas of possible land slip.

Design Summary (refer to sheet SK1-SK3 for approximate wall locations)

Typical Retaining Wall

- Retained and founding material to be Stiff Natural Ground or Controlled Fill (Class 2 min. - AS4678)
- Near flat ground in front and behind the wall
- No services in the vicinity of the wall
- Q100 below base of wall

(Where site conditions vary from those noted, the engineer should be consulted for re-design)

Footings

Wall Height	Footing Pier Diameter	Footing Depth	Pier Reinforcement
750mm and less	350mm	Wall Height + 300mm*	Post Reinforcing
900mm to 1200mm	350mm	Wall Height + 400mm	Post Reinforcing
1350mm to 1500mm	350mm	Wall Height + 450mm	Extend rear bars to base
900mm and less	450mm	Wall Height + 200mm*	Post Reinforcing
900mm to 1200mm	450mm	Wall Height + 250mm	Post Reinforcing
1350mm to 1500mm	450mm	Wall Height + 300mm	Extend rear bars to base

Notes:

- Refer to note (3) specifically relating to services. Builder to confirm depths and locations of any services prior to any construction work of retaining walls.
- All posts to be Hot Dip Galvanised after fabrication
- Bar laps to be N12-500mm, N16-600mm, N20-800mm, N24-1000mm, N28-1200mm and N32-1400mm
- * Denotes footing pier to be 1000mm deep min

Retaining Wall 'A'

- Retained and founding material to be Very Stiff Natural Clay or Medium Dense Natural Sand or Controlled Sandy Clay Fill (Class 2 min. - AS4678) from onsite cuts
- Near flat ground behind wall
- 2.5m min. level ground in front of wall then 1V:3H maximum batter slope
- No services in the vicinity of the wall
- Q100 level approx. 750mm max. above the base of the wall
- Buoyant foundation ground
(Where site conditions vary from those noted, the engineer should be consulted for re-design)

Footings

Wall Height	Footing Pier Diameter	Footing Depth	Pier Reinforcement
1350mm to 1500mm	450mm	Wall Height + 950mm	Extend rear bars to base
1650mm to 1800mm	450mm	Wall Height + 1050mm	2/N24 bars full height
1950mm	600mm	2800mm	2/N20 bars full height
2100mm	600mm	3050mm	2/N24 bars full height
2250mm	600mm	3250mm	2/N24 bars full height

Notes:

- Refer to note (3) specifically relating to services. Builder to confirm depths and locations of any services prior to any construction work of retaining walls.
- All posts to be Hot Dip Galvanised after fabrication
- Bar laps to be N12-500mm, N16-600mm, N20-800mm, N24-1000mm, N28-1200mm and N32-1400mm

Retaining Wall 'B'

- Retained and founding material to be Very Stiff Natural Clay or Medium Dense Natural Sand or Controlled Sandy Clay Fill (Class 2 min. - AS4678) from onsite cuts
- Near flat ground in front and behind the wall u.n.o.
- No services in the vicinity of the wall
- Q100 level approx. 600mm max. above the base of the wall
- Buoyant foundation ground
(Where site conditions vary from those noted, the engineer should be consulted for re-design)

Footings

Wall Height	Footing Pier Diameter	Footing Depth	Pier Reinforcement
600mm and less	450mm	1000mm	Post Reinforcing
750mm	450mm	1250mm	Extend rear bars to base
900mm	450mm	1450mm	Extend rear bars to base
1050mm	450mm	1700mm	Extend rear bars to base

Notes:

- Refer to note (3) specifically relating to services. Builder to confirm depths and locations of any services prior to any construction work of retaining walls.
- All posts to be Hot Dip Galvanised after fabrication
- Bar laps to be N12-500mm, N16-600mm, N20-800mm, N24-1000mm, N28-1200mm and N32-1400mm

Retaining Wall 'C'

- Retained and founding material to be Very Stiff Natural Clay or Medium Dense Natural Sand or Controlled Sandy Clay Fill (Class 2 min. - AS4678) from onsite cuts
- Near flat ground in front and behind the wall
- Lighting conduit along front of wall in fully compacted trench.
- 160mm Sewer pipe behind partial length of wall
(Where site conditions vary from those noted, the engineer should be consulted for re-design)

Footings

Wall Height	Footing Pier Diameter	Footing Depth	Pier Reinforcement
600mm and less	350mm	1100mm	Post Reinforcing

Notes:

- Refer to note (3) specifically relating to services. Builder to confirm depths and locations of any services prior to any construction work of retaining walls.
- All posts to be Hot Dip Galvanised after fabrication
- Bar laps to be N12-500mm, N16-600mm, N20-800mm, N24-1000mm, N28-1200mm and N32-1400mm

Terraced Retaining Wall 1

- Retained and founding material to be Very Stiff Natural Clay or Medium Dense Natural Sand or Controlled Sandy Clay Fill (Class 2 min. - AS4678) from onsite cuts
- 2m min. of level ground in front of wall before 1V:2H max. batter slope
- Near flat ground behind rear wall and in between walls
- 150/225/300mm Diam. Roof water pipe approx. 1m min. clear behind rear wall
- 160mm Diam. Sewer pipe 2.2m min. clear behind rear wall
- 1m min. bench between walls
(Where site conditions vary from those noted, the engineer should be consulted for re-design)

Refer Sheet S8-S9

Terraced Retaining Wall 2

- Retained and founding material to be Very Stiff Natural Clay or Medium Dense Natural Sand or Controlled Sandy Clay Fill (Class 2 min. - AS4678) from onsite cuts
- Near flat ground behind rear wall and in between walls
- 400mm segmental garden bed wall approx. 1m over boundary into neighbouring site
- No services in the vicinity of the wall
- Swale behind rear wall
- 1m min. bench between walls
(Where site conditions vary from those noted, the engineer should be consulted for re-design)

Refer Sheet S8-S9

Where sleeper walls pass over services, the builder should ensure they are located on-site and that the minimum footing clearance is provided in accordance with council requirements. Post footing piers either side of services should be founded a minimum of 300mm below the invert level of the services.

The design is also based on the assumption that after cutting, filling and compacting the site, the surface level for the retaining walls will be stiff natural ground or controlled compacted fill (150 kPa minimum allowable bearing capacity). If this is not the case and the surface is a soft or loose material, then the engineer should be consulted for a re-design or this material is to be removed and replaced with controlled fill (class 1 & level 1).

The retained and founding soil design parameters are based upon information contained in the geotechnical investigation by Morrison Geotechnic in report (Job No. DE19-288/15304) dated 3 September 2019 and Broadscale Geotechnical Investigation by Morrison Geotechnic (Job No. DE16/350/21518) dated 14 December 2016. Any additional soil testing information is to be provided to the engineer prior to commencement of construction.

The retaining wall design uses the following assumptions and soil parameters:

Criteria	Value	
Retained Material: Very Stiff Natural Clay or Medium Dense Natural Sand or Controlled Sandy Clay Fill (Class 2 min. - AS4678) from onsite cuts	Density	21 kN/m ³ (Fill) 20 kN/m ³ (Clay)
	Characteristic Soil Friction Angle	26 degrees (Fill) 24 degrees (Clay)
	Material Capacity Reduction Factor	0.9 (Fill) 0.85 (natural)
	Characteristic Cohesion	1 kPa (Fill) 2 kPa (Clay)
	Material Capacity Reduction Factor	0.75 (Fill) 0.7 (Clay)
	Founding Material: Very Stiff Natural Clay or Medium Dense Natural Sand or Controlled Sandy Clay Fill (Class 2 min. - AS4678) from onsite cuts	Density
Characteristic Soil Friction Angle		26 degrees (Fill) 24 degrees (Clay)
Material Capacity Reduction Factor		0.9 (Fill) 0.85 (natural)
Characteristic Cohesion		1 kPa (Fill) 2 kPa (Clay)
Material Capacity Reduction Factor		0.75 (Fill) 0.7 (Clay)
Geometry:		Slope on Top of Wall
	Slope at Base of Walls	Refer summary
Loads:	Live Loads (Imposed Loads)	5 kPa
Load Factors:	Soil Load	1.25
	Live Loads (Imposed Loads)	1.5

Note: The walls are not designed to support building loads.

The design of the retaining walls is based upon the requirements of AS 4678-2002 “Earth-retaining structure” for a structure classification B, and AS 3600 “Concrete Structures Code”.

The walls are to be constructed using Concrib Retaining Wall’s “Concrete Sleeper Retaining Wall” system. The system consists of vertical Hot Dip Galvanized Steel Posts at 2m centres (except as directed on site or noted otherwise in this report) and horizontal concrete sleepers as shown on the following drawings.



For and on behalf of
Inertia Engineering Pty Ltd.
David Kelly
BE Civil (Hons.), RPEQ 7561.

Notes:

1. The wall is to be constructed in accordance with Concrib specifications. This certification only applies to sleeper walls constructed using Concrib manufactured products. If other manufactured products are substituted the certificate becomes null and void.
2. Footings to be founded in material complying with the design criteria. Advise the engineer should any design criteria not apply.
3. Stormwater, sewer, water supply, electricity and communication service trenches are not to be located in front of the wall within a distance equal to twice the depth of the trench u.n.o. Advise the engineer should a service be located in this zone. Compaction testing of the service trench backfill and additional pier depth will be required. The trench backfill shall be compacted to at least: (a) 95% MDD (Standard) at 800mm and greater above the top of the pipe; (b) 85% MDD (Standard) at 500mm above the top of the pipe or backfill with stabilized sand or no fines concrete
4. The height is measured as the height of the material being retained at the back of the wall.
5. Ensure the wall is not constructed to heights greater than stated above.
6. The wall is not intended to support surcharge from buildings. The underside of a building footing is not to be located above a line drawn from the bottom of the retaining wall at a slope of 1.5 horizontal to 1 vertical where in clay soil and at a slope of 2 horizontal to 1 vertical where in sand.
7. The design engineer must be consulted before excavating any ground in front of a retaining wall. Excavation may undermine the retaining wall and cause wall instabilities.
8. Unless noted otherwise the retaining wall is designed to support a timber fence 1.8m high, for a site ultimate wind speed of 40m/s (N2 wind classification) and a net pressure coefficient of 1.2. The fence posts may connect directly to the steel retaining wall posts with an approved method. Alternatively the fence may have separate appropriately designed footings which are to be located directly behind the posts. The fence is to extend beyond the end of the wall or return at right angles for at least 3.6m.
9. Some horizontal movement of the wall may occur after construction. Elements sensitive to ground movement should not be located within a horizontal distance equal to the height of the wall.
10. Imported fill to embankments to be retained shall have a shrink/swell index of not greater than 1.0%.
11. It is preferable to overfill embankments and then trim back for the retaining wall which will ensure compaction. If circumstances arise and the wall must be backfilled after construction then use controlled fill (Class 2 minimum) in accordance with AS4678 [Cl 1.4.3.3]. The compaction within 1m behind the wall or within a distance behind the wall that is equal to the wall height (whichever is greater) must be carried out by hand held pneumatic compaction equipment as heavy machinery should not be used close to the wall.
12. Backfill behind retaining walls with free draining granular material encompassing a continuous 100mm diameter slotted pvc pipe with a fall to a legal point of discharge under and beyond the front of the wall at 20m maximum centres. Provide geofabric between granular material and embankment/top cover material and lap geofabric 200mm minimum. Top plug/cover material to be 600mm thick of clayey material compacted by hand operated equipment. Ensure a minimum 200mm thickness of granular material for all sites. Where retaining walls are greater than 2m high, increase the width of free draining granular material to average an additional one eighth (1/8) of the wall height where the retained material is of reactivity class 'H' or greater.
13. Construct the face of walls in expansive soil sites to lean into the retained material with a face slope of 1 horizontal to 50 vertical.
14. On expansive soil sites the wall may move after construction due to variations in soil moisture content.
15. Stormwater/Surface water is not to be directed and concentrated to an area whereby discharging over or into a sleeper retaining wall.
16. Sleeper units which have been cut to length shall have the exposed cross-section of reinforcing bar coated with a two pack structural epoxy (e.g. Fosroc – Lokset E with a 1mm minimum thickness coating)
17. The minimum bearing of the sleeper panel behind the front flange shall be 30mm for walls up to and including 1.5m high and 40mm for walls 1.65m and higher.
18. Sleeper units shall be continuous between posts.
19. Steel posts to be Hot Dip Galvanised after fabrication in accordance with AS4680. Minimum zinc coating thickness to be 600g/m²
20. Fill any gaps greater than 10mm between the face of a sleeper panel and the post. The gap is to be measure as the distance between the outer face of each sleeper within the panel and the rear of the post.
21. Repair local damage (e.g. broken corners) to posts and sleepers with non-shrink grout (minimum compressive strength 50MPa).
22. Seek direction from the engineer regarding action to repair or replace any severely damaged or cracked sleepers or posts.
23. Where trimming the end of sleeper panels over concrete footing piers at stepping walls, a 150mm (Max.) high to be notched from a 450mm high or greater Panels. If larger a 300mm (Max.) high notch from a 750mm high panel is allowable.
24. Sleeper walls designed for stability whilst all service trenches are backfilled & compacted as per note 3 above. If service trenches near walls need to be excavated then temporary propping or dismantling of the sleeper wall will be required due to instability.
25. Footings for single wall height posts at intersections where there is a step between lots should be typical for the total length of the post even where the retained height is less.
26. It is assumed that electrical and NBN trenches are installed prior to construction of retaining walls. Advise engineer if otherwise.

NOTES

- A**: CUSTOM POST
- B**: BRIDGE SERVICE PIPE
- C**: CORNER POST
- E**: EQUAL ANGLED POST TO PANELS

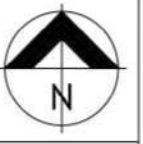

LEGEND - PROPOSED

- EXTENT OF CUT
- EXTENT OF FILL
- FINISHED MAJOR CONTOURS (1.00m)
- FINISHED MINOR CONTOURS (0.20m)
- BUILDING PAD LINES
- PAD LEVEL
- RETAINING WALL HEIGHT RANGE
- CONCRETE SLEEPER RETAINING WALL. TOP AND BASE OF WALL LEVELS AS NOTED. FOR SECTIONS REFER BULK EARTHWORKS NOTES AND DETAILS.
- MASONRY RETAINING WALL. TOP AND BASE OF WALL LEVELS AS NOTED. FOR SECTIONS REFER BULK EARTHWORKS NOTES AND DETAILS.
- CAST-IN-SITU CONCRETE RETAINING WALL
- EXISTING INTEGRATED RETAINING AND NOISE WALL
- WORKS BOUNDARY
- EXISTING WETLAND BOUNDARY EXCLUSION ZONE

LEGEND - EXISTING

- MAJOR CONTOURS (1.00m)
- MINOR CONTOURS (0.20m)
- STORMWATER
- GRAVITY SEWER
- VACUUM SEWER
- WATER
- ELECTRICITY
- TELECOMMUNICATIONS
- GAS
- SPOT LEVEL

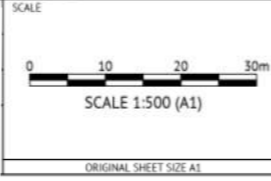
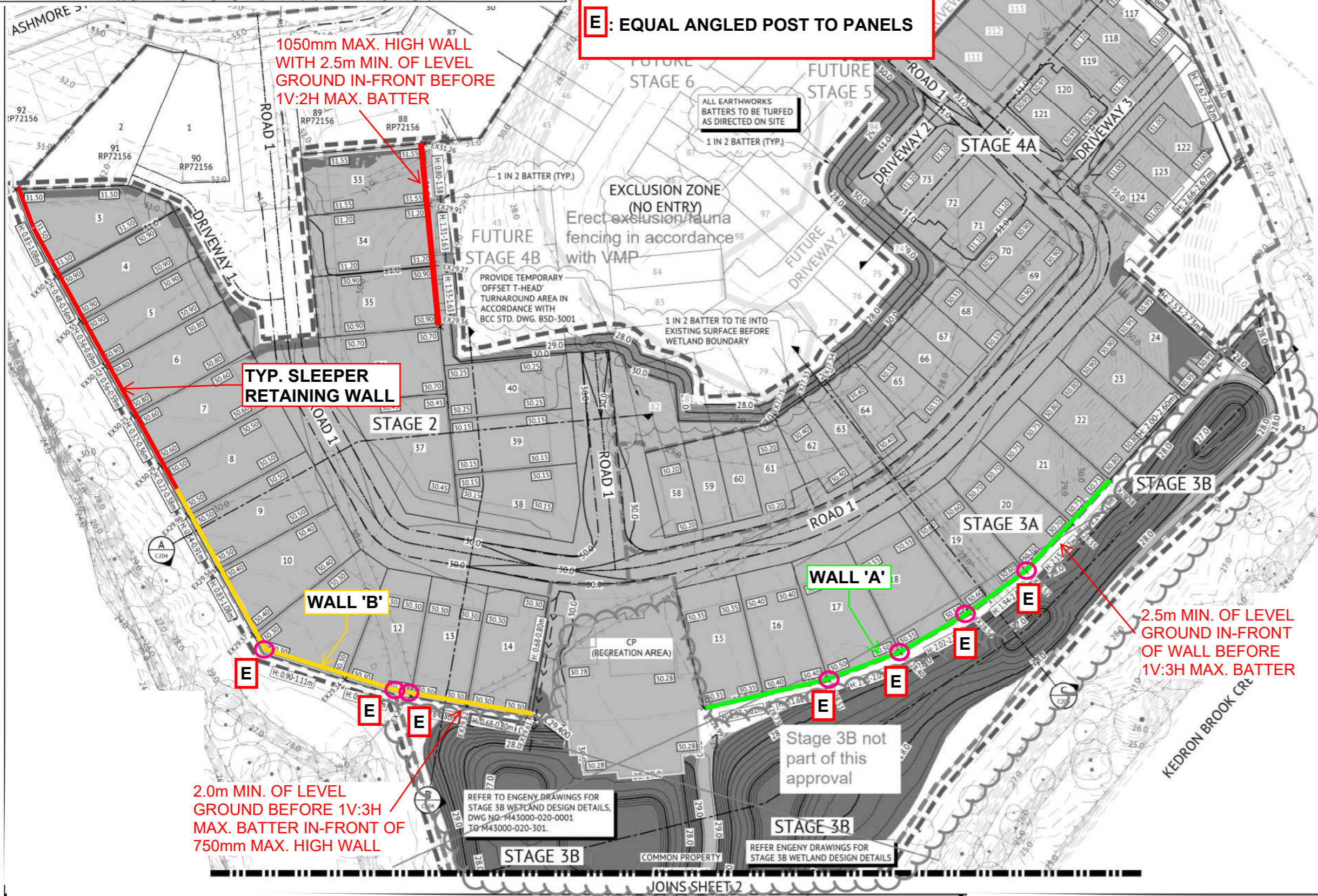

PROJECT: PROPOSED DEVELOPMENT - STAGE 2, 3A, 3B & 4A (54 LOTS)
 LOCATION: 420 SOUTH PINE ROAD - EVERTON PARK
 SHEET TITLE: BULK EARTHWORKS LAYOUT PLAN - SHEET 1

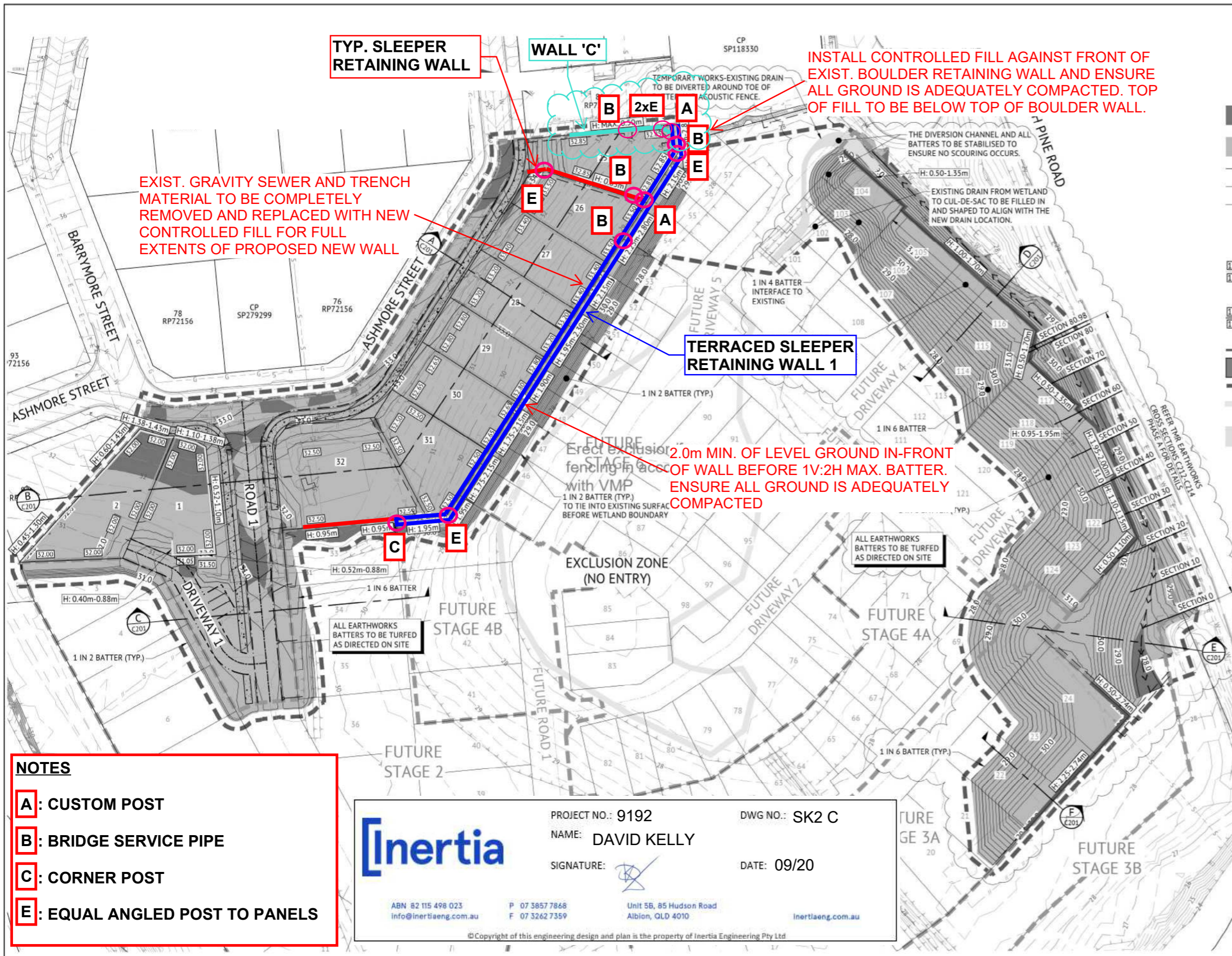

LEGEND - PROPOSED

- EXTENT OF CUT
- EXTENT OF FILL
- FINISHED MAJOR CONTOURS (1.00m)
- FINISHED MINOR CONTOURS (0.20m)
- BUILDING PAD LINES
- PAD LEVEL
- RETAINING WALL HEIGHT RANGE
- CONCRETE SLEEPER RETAINING WALL. TOP AND BASE OF WALL LEVELS AS NOTED. FOR SECTIONS REFER BULK EARTHWORKS NOTES AND DETAILS.
- MASONRY RETAINING WALL. TOP AND BASE OF WALL LEVELS AS NOTED. FOR SECTIONS REFER BULK EARTHWORKS NOTES AND DETAILS.
- INTEGRATED RETAINING AND NOISE WALL
- TMR RESUMPTION BOUNDARY EXTENT
- WORKS BOUNDARY
- EXISTING WETLAND BOUNDARY EXCLUSION ZONE
- PROPOSED TEMPORARY WETLAND DIVERSION DRAIN

LEGEND - EXISTING

- MAJOR CONTOURS (1.00m)
- MINOR CONTOURS (0.20m)
- STORMWATER
- GRAVITY SEWER
- VACUUM SEWER
- WATER
- ELECTRICITY
- TELECOMMUNICATIONS
- GAS

- NOTES**
- A**: CUSTOM POST
 - B**: BRIDGE SERVICE PIPE
 - C**: CORNER POST
 - E**: EQUAL ANGLED POST TO PANELS



PROJECT NO.: 9192 DWG NO.: SK2 C
 NAME: DAVID KELLY
 SIGNATURE: DATE: 09/20

ABN 82 115 498 023 P 07 3857 7868 Unit 5B, 85 Hudson Road Albion, QLD 4010 inertiaeng.com.au
 Info@inertiaeng.com.au F 07 3262 7359



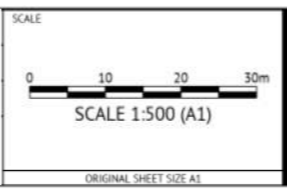



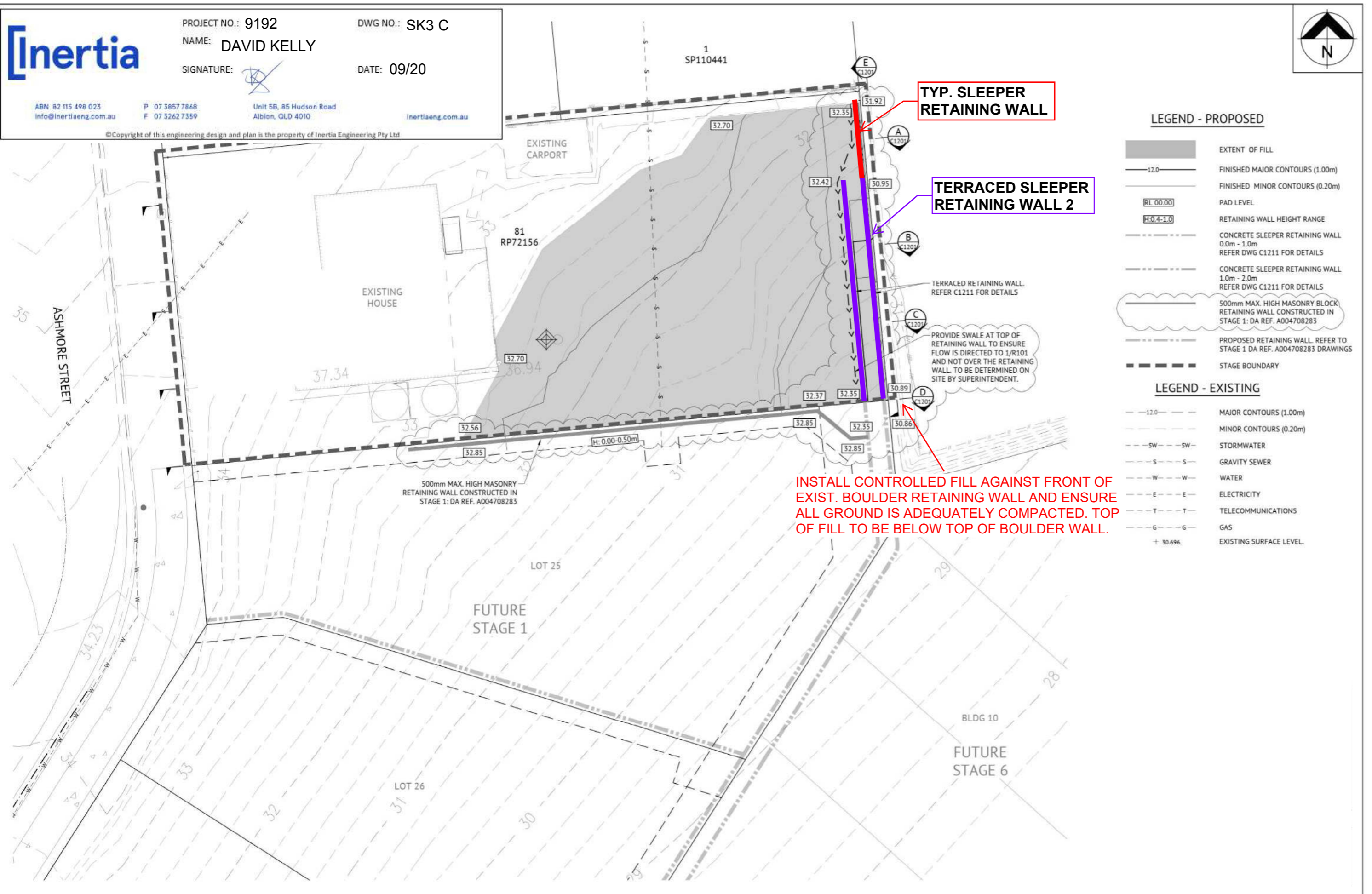

© Copyright of this engineering design and plan is the property of Inertia Engineering Pty Ltd

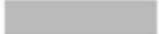
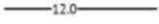

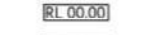
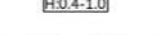







PROJECT **PROPOSED DEVELOPMENT - STAGE 1 (11 LOTS)**
 LOCATION **420 SOUTH PINE ROAD - EVERTON PARK**
 SHEET TITLE **BULK EARTHWORKS LAYOUT PLAN - PHASE A**

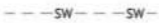

LEGEND - PROPOSED

-  EXTENT OF FILL
-  -12.0- FINISHED MAJOR CONTOURS (1.00m)
-  FINISHED MINOR CONTOURS (0.20m)
-  PAD LEVEL
-  RETAINING WALL HEIGHT RANGE
-  CONCRETE SLEEPER RETAINING WALL 0.0m - 1.0m REFER DWG C1211 FOR DETAILS
-  CONCRETE SLEEPER RETAINING WALL 1.0m - 2.0m REFER DWG C1211 FOR DETAILS
-  500mm MAX. HIGH MASONRY BLOCK RETAINING WALL CONSTRUCTED IN STAGE 1: DA REF. A004708283
-  PROPOSED RETAINING WALL. REFER TO STAGE 1 DA REF. A004708283 DRAWINGS
-  STAGE BOUNDARY

LEGEND - EXISTING

-  -12.0- MAJOR CONTOURS (1.00m)
-  MINOR CONTOURS (0.20m)
-  -SW--SW- STORMWATER
-  -S---S- GRAVITY SEWER
-  -W---W- WATER
-  -E---E- ELECTRICITY
-  -T---T- TELECOMMUNICATIONS
-  -G---G- GAS
-  + 30.696 EXISTING SURFACE LEVEL

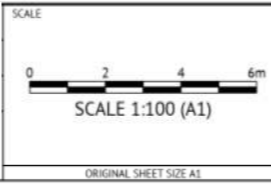

PROJECT **PROPOSED FILLING EARTHWORKS - LOT 81 RP72156**
 LOCATION **34 ASHMORE STREET - EVERTON PARK**
 SHEET TITLE **BULK EARTHWORKS LAYOUT PLAN**

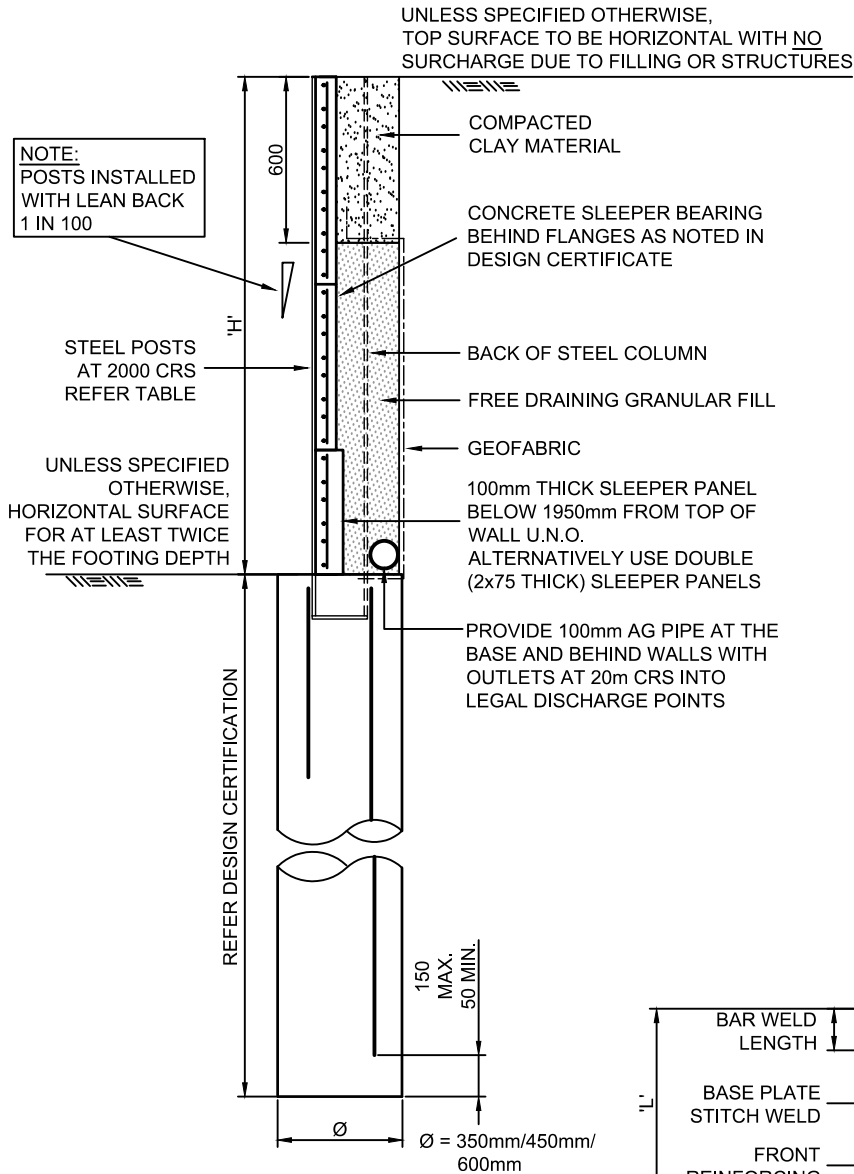

**SECTION -
TYPICAL SLEEPER WALL**

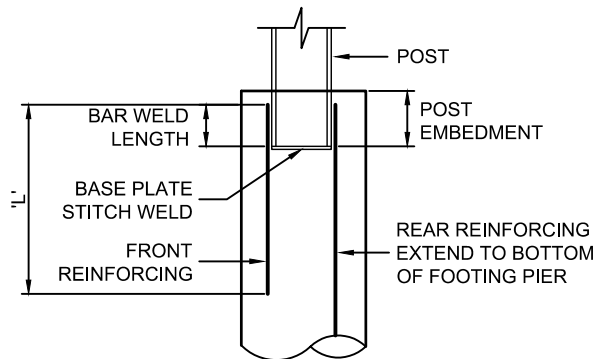

**TYPICAL POST BASE DETAIL
(H = 0-2550mm)**

REFER ALSO SHEET S3

NOTES:

- DESIGN IS BASED UPON:
EARTH-RETAINING STRUCTURES CODE AS 4678
CONCRETE STRUCTURES CODE AS 3600
BRIDGE DESIGN (PART 5 CONCRETE) AS 5100.5
STEEL STRUCTURES CODE AS 4100
BUILDING CODE OF AUSTRALIA
PROTOTYPE TESTING AT THE UNIVERSITY OF QUEENSLAND
- LAND SLIPS (E.G. SLIP CIRCLE FAILURE MECHANISMS) HAVE NOT BEEN CONSIDERED IN THE RETAINING WALL DESIGN. THE DESIGN IS BASED UPON THE ASSUMPTION THAT THE WALL IS FOUNDED ON GROUND NOT SUBJECT TO SLIP. THE DETERMINATION OF THE SITE SUSCEPTIBILITY TO SLIP IS THE RESPONSIBILITY OF THE PROJECT ENGINEER AND THE GEOTECHNICAL CONSULTANT AND IS BEYOND THE SCOPE OF WORK OF CONCRIB AND INERTIA ENGINEERING PTY LTD.
- RETAINING WALL DESIGNED FOR 5kPa IMPOSED LOADING U.N.O.
- FOR 60yr DESIGN LIFE (AS 3600)
40 MPa CONCRETE WITH 25mm COVER FOR SLEEPER PANELS MORE THAN 2km FROM ALL COASTLINE.
50 MPa CONCRETE WITH 25mm COVER FOR SLEEPER PANELS WITHIN 1km FROM THE COAST AND UP TO 2km FROM BREAKING SURF AND WHERE IN BIO-RETENTION BASINS.
- FOR 100yr DESIGN LIFE (AS 5100)
50MPa CONCRETE WITH 40mm COVER FOR SLEEPER PANELS SUITS B2 EXPOSURE CLASSIFICATION & 30mm COVER FOR B1 CLASSIFICATION.

DESIGN PARAMETERS

REFER DESIGN CERTIFICATION FOR RETAINED AND FOUNDING SOIL DESIGN PARAMETERS, DESIGN SURCHARGE LOADS AND WALL DESIGN GEOMETRY

CONCRETE STANDARD - AS 3600
STANDARD DESIGN EXPOSURE CLASSIFICATION
SLEEPERS & POSTS - B1, FOOTINGS - A2

ELEMENT	GRADE	SLUMP	MIN. COVER
SLEEPER	N40	50mm	25mm*
FOOTING	N25	80mm	75mm

* RIGID FORMWORK & INTENSE COMPACTION

REINFORCEMENT

STANDARD - AS/NZS 4671
YIELD 500 MPa;
- POST AND FOOTING REINFORCEMENT TO BE DUCTILITY CLASS N
- PANEL REINFORCEMENT TO BE DUCTILITY CLASS L

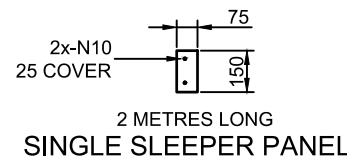
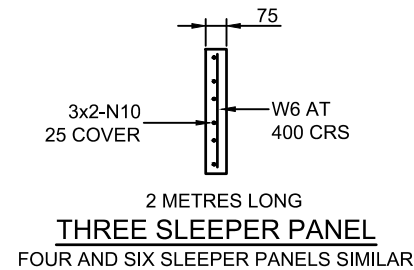
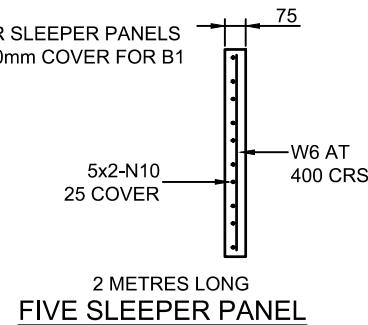
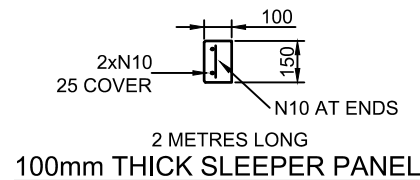

Unit: 59/85 Hudson Road
Abbotsford, QLD 4010
Phone: 3857 7868
E-mail: info@inertiaeng.com.au
Fax: 3262 7359
© COPYRIGHT of this engineering design and plan is the property of INERTIA ENGINEERING Pty Ltd

PROJECT
No. 420 SOUTH PINE ROAD
EVERTON PARK

TITLE
CONCRIB SLEEPER WALL
SYSTEM DETAILS

DESIGN SCALE
D.M.K. A4 Sheet : NOT TO SCALE

DRAWN DATE
D.H. 09/2020

DRAWING NUMBER
9192 S4 C
JOB No SHEET No ISSUE

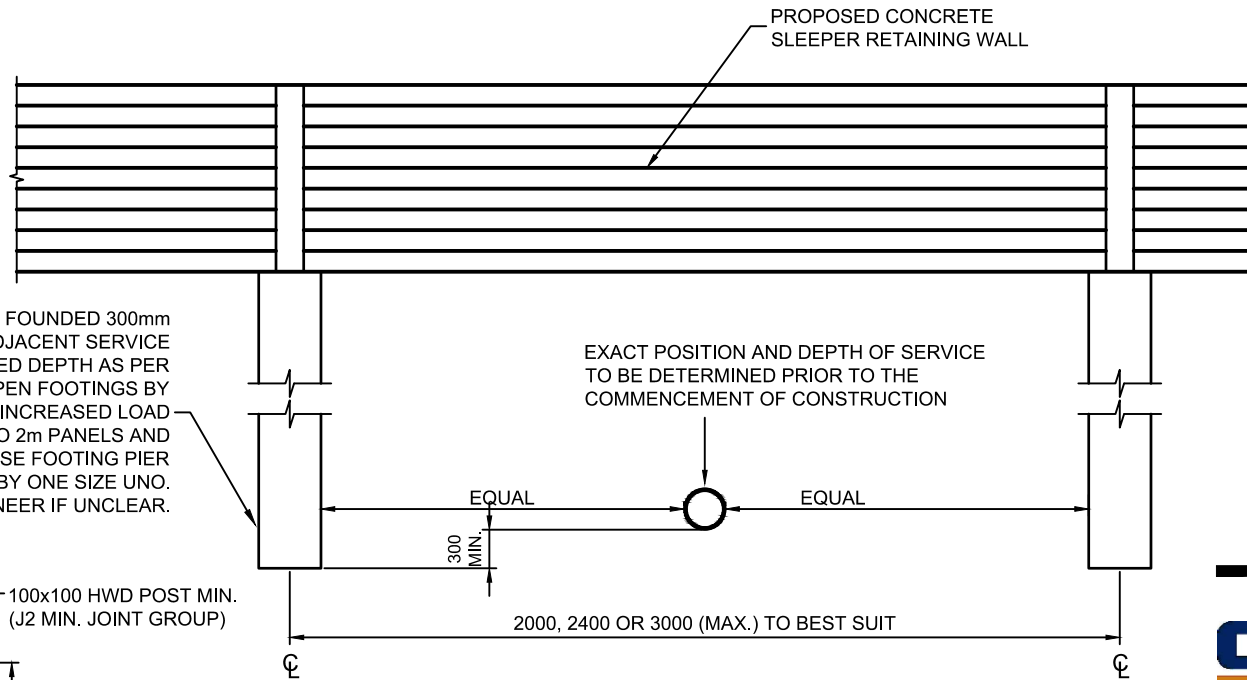

BORED PIER TO BE FOUNDED 300mm BELOW INVERT OF ADJACENT SERVICE PIPE AND TO REQUIRED DEPTH AS PER DESIGN. DEEPEN FOOTINGS BY EQUIVALENT % OF INCREASED LOAD WIDTH COMPARED TO 2m PANELS AND INCREASE FOOTING PIER REINFORCEMENT BY ONE SIZE UNO. CONTACT ENGINEER IF UNCLEAR.

EXACT POSITION AND DEPTH OF SERVICE TO BE DETERMINED PRIOR TO THE COMMENCEMENT OF CONSTRUCTION

300 MIN.

EQUAL

EQUAL

2000, 2400 OR 3000 (MAX.) TO BEST SUIT

SAW CUT CENTRE OF TIMBER POST TO ACCOMMODATE STEEL PLATE.
2-M12 GALV. BOLT FIXING (GR.4.6)

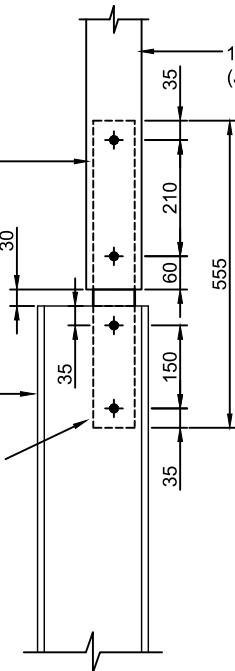

100x100 HWD POST MIN. (J2 MIN. JOINT GROUP)

75 WIDE x 555 LONG x 8mm THICK PLATE (GRADE 400)
2-M12 (GR.10.6) GALV. COUNTERSINK BOLT FIXING

TYPICAL SLEEPER WALL BRIDGING DETAIL

NOTES:

- PROVIDE ADDITIONAL POSTS AND POSITION AS REQUIRED TO ACHIEVE CLEARANCES.

**1800 MAX. FENCE HEIGHT
(POSTS AT 2000 CRS.)**

N2 WIND CLASSIFICATION

NOTE:
INSTALL COUNTERSINK
IN 8mm THICK PLATE



Unit 5B/85 Hudson Road
Abion, QLD 4010
Phone: 3857 7888
E-mail: info@inertiaeng.com.au
Fax: 3262 7359
©COPYRIGHT of this engineering design and plan is the property of INERTIA ENGINEERING Pty Ltd

PROJECT
No. 420 SOUTH PINE ROAD
EVERTON PARK

TITLE
CONCRIB SLEEPER WALL
SYSTEM DETAILS

DESIGN	SCALE
D.M.K.	A4 Sheet : NOT TO SCALE
DRAWN	DATE
D.H.	09/2020

DRAWING NUMBER		
9192	S6	C
JOB No	SHEET No	ISSUE

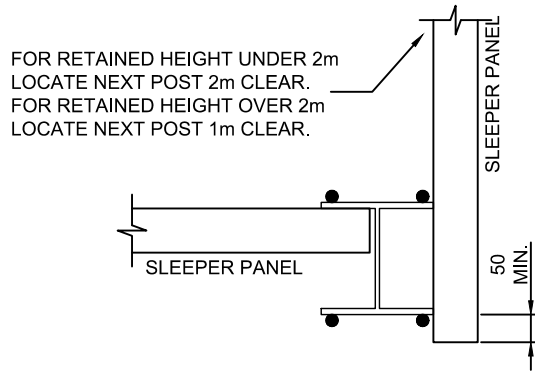

**PLAN VIEW
(INTERNAL CORNER POST)**

NOTE: ALL 4 BARS TO BE EXTENDED TO BASE OF FOOTING.

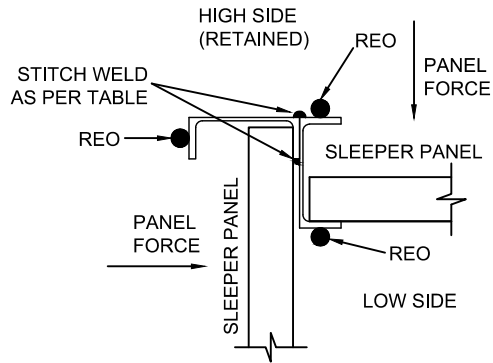

**PLAN VIEW
(INTERNAL CORNER POSTS
OVER 2m RETAINING HEIGHT)**

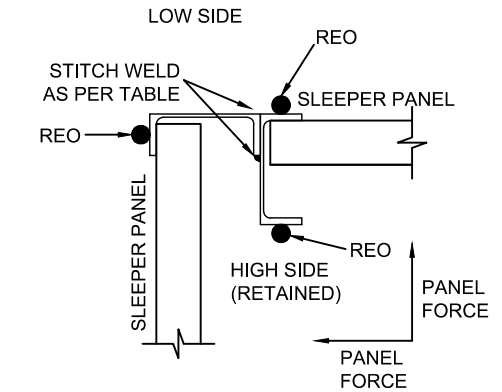

**PLAN VIEW
(EXTERNAL CORNER POSTS)**

**PFC EXTERNAL CORNER POST DETAILS
AND REINFORCING TABLE**
SINGLE HEIGHT WALLS

RETAINING WALL MAX. HEIGHT 'H' (mm)	GALV. POST SIZE	PIER DIA. (Ø)	POST EMBEDMENT (mm)	BASE PLATE (mm)	REINFORCING (3 BAR)	REINFORCING LENGTH (L)	WELD LENGTH (mm)	STITCH WELD BOTH SIDES OF PFC FLANGE
1200	100 PFC	450	200	6	N20	1100	150	HIT 50, MISS 100
1650	125 PFC	600	250	6	N24	1400	200	HIT 50, MISS 100
2250	150 PFC	600	300	10	N28	1650	250	HIT 50, MISS 100
2700	200 PFC	600	350	10	N32	1900	300	HIT 50, MISS 100
3000	230 PFC	750	400	10	N36	2150	350	HIT 50, MISS 100
3300	250 PFC	750	400	10	N36	2150	350	HIT 50, MISS 100

NOTE: WELD LENGTH APPLIES TO BOTH SIDES OF EACH REINFORCING BAR.
ALL 3 BARS TO BE EXTENDED TO BASE OF FOOTING PIER.

NOTE:
H.D. GALVANISE ALL STEELWORK POSTS AFTER FABRICATION.

75x6 EA WHERE REQUIRED
STITCH WELD BOTH SIDES
(HIT 50, MISS 100)

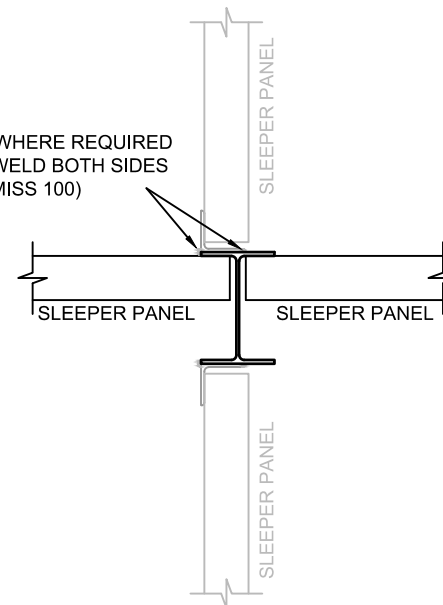

**CUSTOM POST DETAIL
(SPECIFIC DESIGNS)**

REFER ALSO SHEET SK1

CONCRIB
Maximising Land Values

Inertia

Unit: 59/85 Hudson Road
Abbotsford, QLD 4010
ABN 82 115 498 023
E-mail: info@inertiaeng.com.au
Phone: 3857 7868
Fax: 3262 7359
© COPYRIGHT of this engineering design and plan is the property of INERTIA ENGINEERING Pty Ltd

PROJECT

No. 420 SOUTH PINE ROAD
EVERTON PARK

TITLE

CONCRIB SLEEPER WALL
SYSTEM DETAILS

DESIGN SCALE

D.M.K. A4 Sheet : NOT TO SCALE

DRAWN DATE

D.H. 09/2020

DRAWING NUMBER

9192

S7

C

JOB No

SHEET No

ISSUE

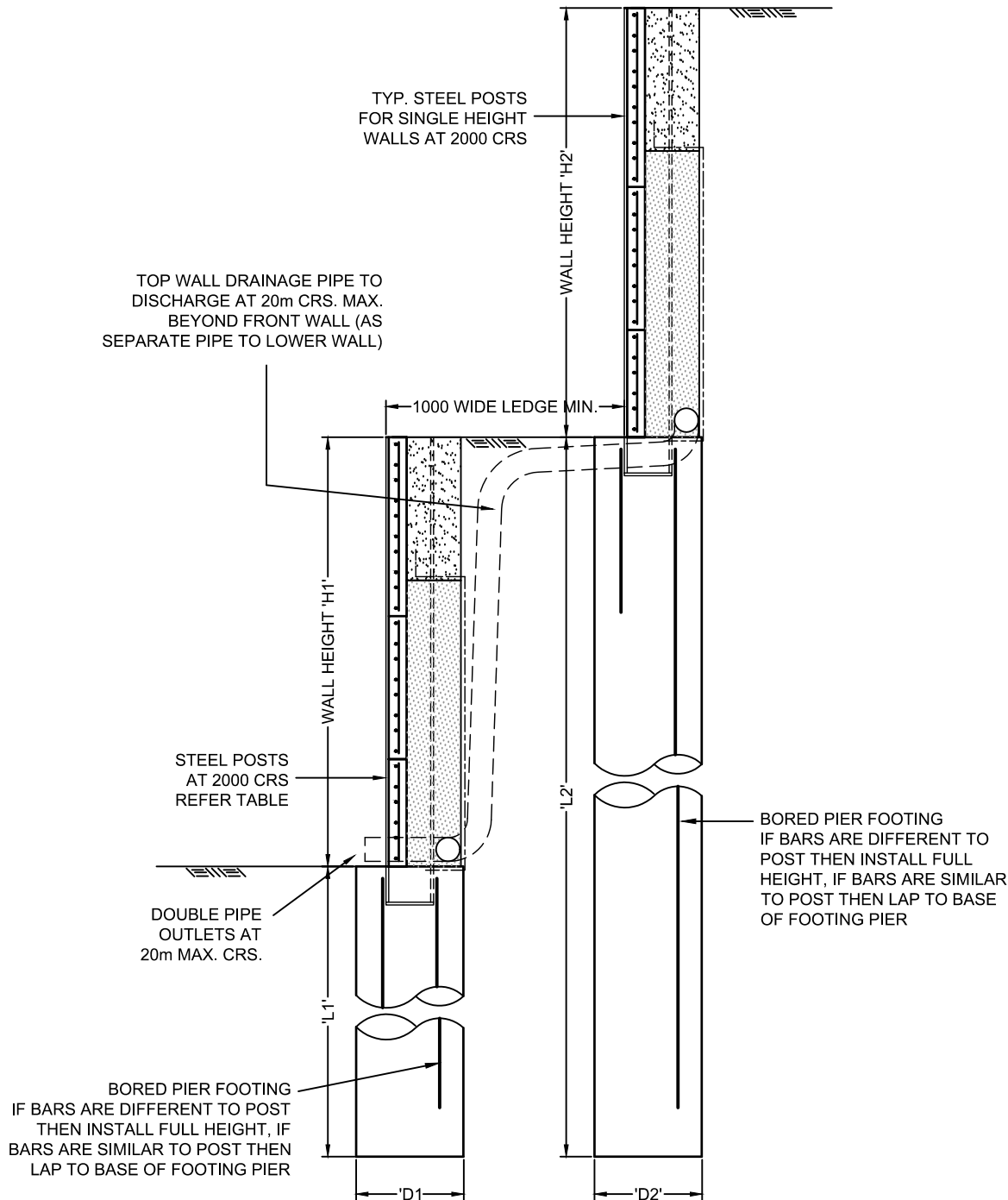

SECTION - TERRACED SLEEPER WALLS

CONCRIB
Maximising Land Values

Inertia

Unit: 59/65 Hudson Road
Abbots: QLD 4010
ABN 82 115 498 023 Phone: 3857 7868
E-mail: info@inertiaeng.com.au Fax: 3262 7359
©COPYRIGHT of this engineering design and plan is the property of INERTIA ENGINEERING Pty Ltd

PROJECT

No. 420 SOUTH PINE ROAD
EVERTON PARK

TITLE

CONCRIB SLEEPER WALL
SYSTEM DETAILS

DESIGN	SCALE
D.M.K.	A4 Sheet : NOT TO SCALE

DRAWN	DATE
D.H.	09/2020

DRAWING NUMBER

9192	S8	C
JOB No	SHEET No	ISSUE

